

LOW VOLTAGE POWER CABLES

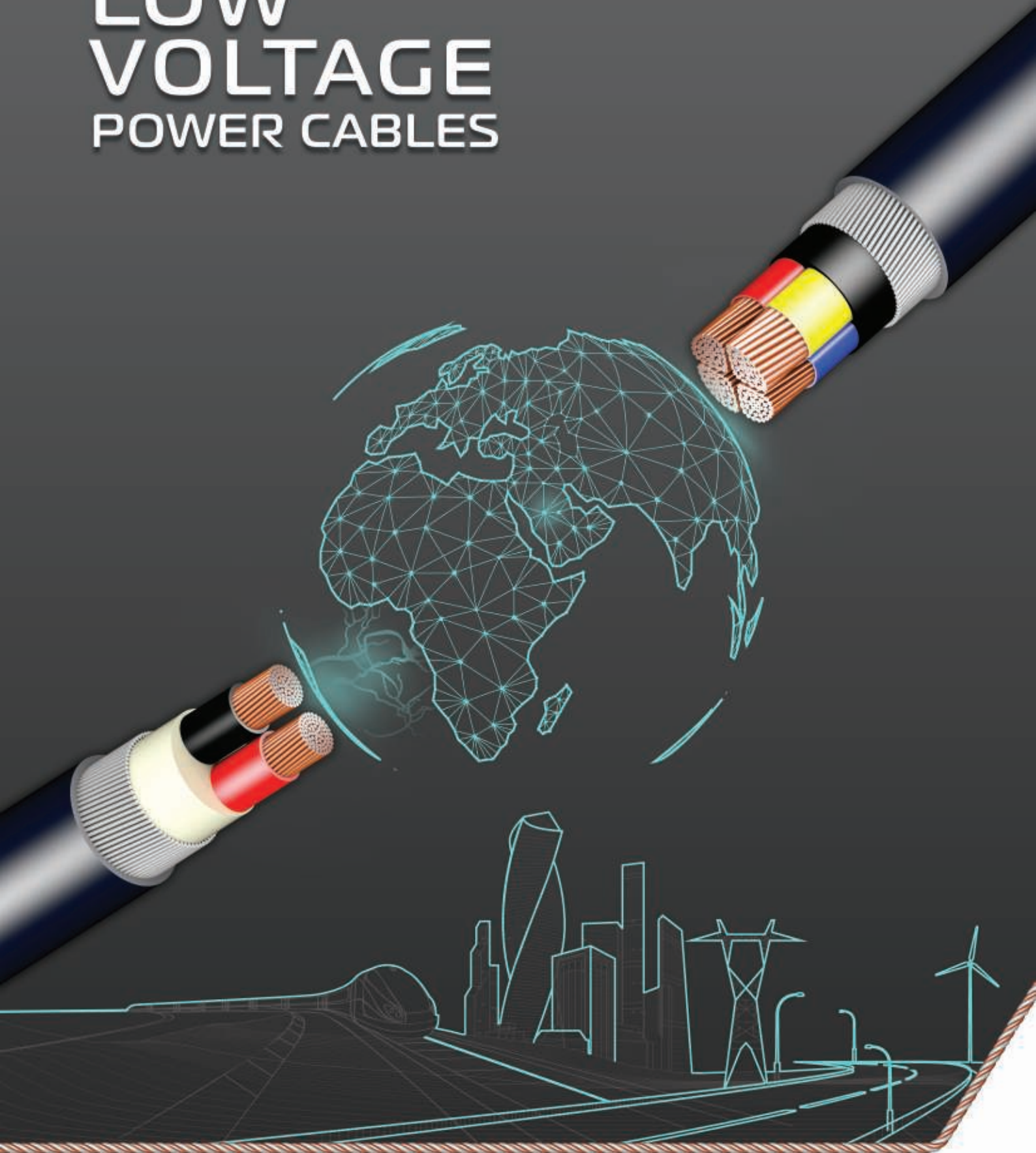

شركة مجموعة كابلات الرياض
Riyadh Cables Group Company

INTRODUCTION

This catalog contains technical information on *Riyadh Cables* low voltage cables including PVC and XLPE insulations of Copper/Aluminium, armoured and un-armoured designs, single and multicore constructions along with a different range of sheathing options. Cables are categorized by insulation and armouring. Each section contains appropriate technical details and constructional data.

PRODUCT SPECIFICATIONS

All cable designs outlined in this catalog use constructions covered by IEC 60502, Please note however that RCGC can also supply a range of alternative designs to meet more specialized customer needs including enhanced fire performance and added environmental protection. Cables can also be supplied with alternative sheathing materials and colours, or can be made to individual customer specifications or other recognized standards both National & International. In particular, cables can be manufactured to meet specific requirements for the elimination of smoke and toxic gases using low smoke and non-halogen materials.

CABLE SELECTION

It is essential that the type of cable ordered is suitable for its intended use. Cable choice will be based on a whole range of factors including installation specifications, relevant local regulations and the performance of appropriate cable types. It is therefore impossible to provide a conclusive guide to cable selection and we would advise you to contact us for our specialist advice on suitable designs to meet your specific cable needs.

CONDUCTORS

Conductors shall be of Copper or Aluminium, circular stranded (Non-compacted or Compacted) or Shaped, Class 2 to IEC 60228, For smaller sizes, a solid circular conductor, Class 1 as per IEC 60228, can also be supplied upon request.

INSULATION

XLPE material and thickness shall be as per IEC 60502 rated for 90°C continuous operation.

PVC material and thickness shall be as per IEC 60502. PVC insulation Material-Type A as per IEC 60502-1.

ASSEMBLY:

Two, Three or Four insulated conductors are laid-up together with non-hygroscopic fillers compatible with the insulation material and the assembly is bedded with an extruded layer of PVC. In case of non-armoured cables, this layer may be omitted if the outer shape of the cable remains practically circular.

INTRODUCTION

COLOUR CODE

Colour code (1) is followed by all utilities in the Middle East and colour of insulation is as mentioned below. However, cables as per colour code (2) mentioned below is also provided based on customer's request.

Colour code (1)

1 Core: Red or Black
2 Core: Red, Black
3 Core: Red, Yellow, Blue
4 Core: Red, Yellow, Blue, Black
5 Core: Red, Yellow, Blue, Black, Green
Above 5 cores: Black Cores with White numerals

Colour code (2)

1 Core: Brown or Blue
2 Core: Brown, Blue
3 Core: Brown, Black, Grey
4 Core: Blue, Brown, Black, Grey
5 Core: Green/Yellow, Blue, Brown, Black, Grey
Above 5 cores: Black Cores with White numerals

ARMOUR:

Galvanized Steel Wires applied helically over the bedding as per IEC 60502 (Single core cables shall be Aluminium wire armoured)

Double steel tapes applied helically over the bedding of multi-core cables as per IEC 60502.

OUTER SHEATH

Outer sheath shall be extruded PVC type ST2 as per IEC 60502-1

Special type of PVC sheathing material such as Fire retardant PVC, anti- termite and anti-rodent PVC, Ultraviolet PVC, Oil resistant PVC, etc are available on request also other special sheathing materials such as LLDPE, MDPE, HDPE, CPE etc are available.

FIRE PERFORMANCE OF CABLE SHEATHS

Cable can be supplied with special flame retardant PVC outer sheath to comply with the flame retardent test requirments of IEC 60332-3-22, IEC 60332-3-23 or IEC 60332-3-24, Riyadh Cables can also supply cables with low smoke Halogen Free (LSHF) material of type ST8 according to IEC 60502-1 or other equivalent standards.

QUALITY ASSURANCE

Effective Quality Assurance procedures are essential to ensure **Riyadh Cables** of the consistency and long term reliability and performance of all products. RCGC has always recognized the importance of Quality Assurance and this commitment is reflected in the company's accreditation. At RCGC Quality Assurance is an integral part of production and supply process and maintained at all stages from order entry and manufacture through testing, packaging and shipping. All Quality Assurance procedures, and systems are regularly audited against International Standards.

MORE INFORMATION FOR LSHF CABLES

Fire is a complex and emotive subject, the consequences of fire can be catastrophic.

The nature of organic material used in the manufacture of cables and possible installation conditions in areas of the fire risk can lead to a situation where cables may contribute to the spread of fire, emission of smoke and release of combustion products injurious to equipment and human health.

In power stations, hospitals, theatres, hotels and other large public buildings, the loss of visibility caused by smoke evolved from burning cable materials can cause panic and create serious problems when evacuating personnel.

Location of the fire source and fire fighting are also greatly hampered by smoke. Additionally the presence of corrosive gases in the smoke result in damage and failure of sensitive electrical equipment and may initiate long term deterioration of structures, as well as being injurious to the health of personnel even after short exposure.

Awareness of this situation has led to the development of new cable technologies and introduction by major cable users of cable types with low emission of smoke, corrosive and toxic fumes and reduced flame propagation properties.

In considering cable systems with improved fire performance characteristics it is useful to first consider the various aspects of the effect of fire on a cable:

- Propagation of fire along cable runs
- Evolution of smoke leading to obstruction of exits
- Evolution of acid gas leading to corrosion of equipment
- Evolution of toxic fumes leading to personal injury

LSHF cables use special formulation based on non-halogenated polymers in order to restrict the generation of smoke as much as possible. Materials are carefully selected and the compounds carefully designed in order to ensure the best performance of the external sheaths, which are directly exposed to fire.

LSHF Cables manufactured by Riyadh Cables group have been designed to offer improved performance in areas where smoke and fume emission in the event of a fire would cause particular problems. Compounds used in LSF cables do not contain halogen hence, do not emit halogenated acids when burnt which help in minimizing the total cost of the damage caused by fire and generate little smoke when burned. Furthermore, the rate at which this low level of smoke is released, is very much slower than that of PVC or similar halogenated polymers.

LSHF Cables manufactured by Riyadh Cables have controlled limits on smoke evolution, when assessed by burning samples of cables in a 3 meter cube smoke chamber as per IEC 61034. Generally these cables combine the properties of low corrosive gas emission and low toxic gas emission as they are essentially halogen free when assessed by IEC 60754-1 and IEC 60754-2.

MORE INFORMATION FOR LSHF CABLES BUNCH BURNING TEST (IEC 60332-3 SERIES)

PURPOSE

This standard describes a method of type approval testing to define the ability of bunched cables to restrain flame propagation in defined conditions regardless of their application, i.e. power, telecommunications (including data transmission and optical fibre cables), etc.

Three categories (A, B and C) are defined and distinguished by test duration and the volume of non-metallic material of the sample under test. Two methods of mounting (designations F/R and F) are application to category A. Only designation F applies to categories B and C.

EQUIPMENT

1. Fire test rig
2. Ladder
3. Ignition source

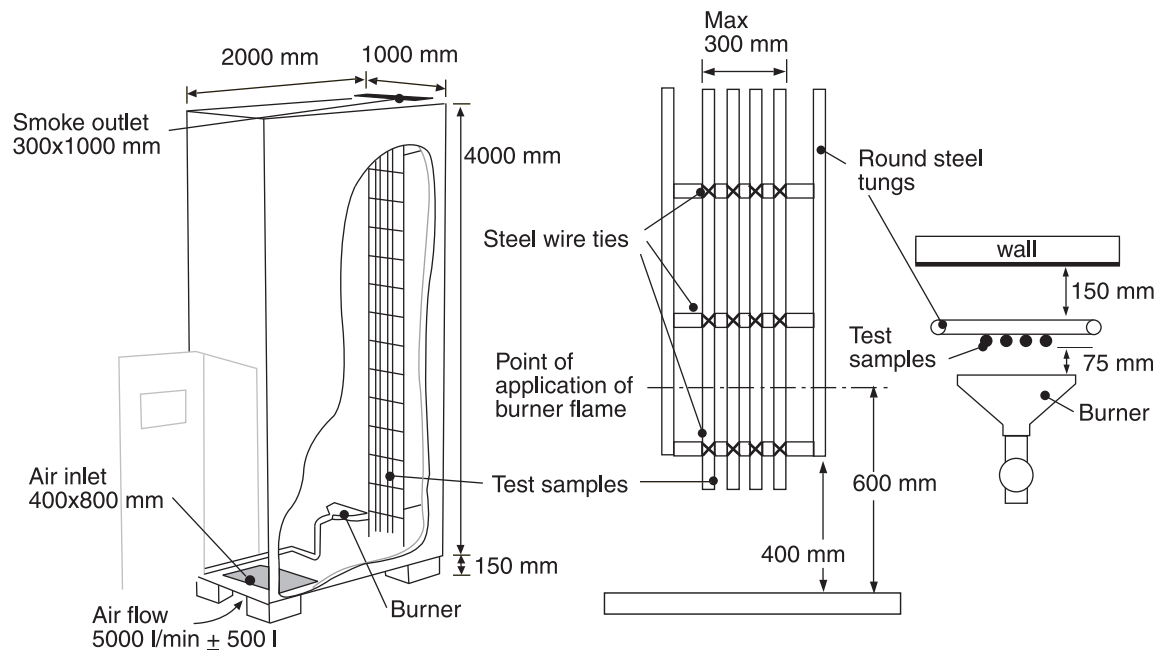

MORE INFORMATION FOR LSHF CABLES
SMOKE DENSITY 3 M TEST CUBE (IEC 61034)

PURPOSE

The measurement of smoke density is an important aspect in the evaluation of the burning performance of electric cables as it is related to the evacuation of persons and accessibility for fire-fighting. The standard describe measurements of smoke emission when electric cables are burned horizontally. The light transmittance for flaming and smouldering conditions can be used when comparing different cables.

EQUIPMENT

1. Cube enclosure
2. Photometric system
3. Fire source
4. Smoke mixer

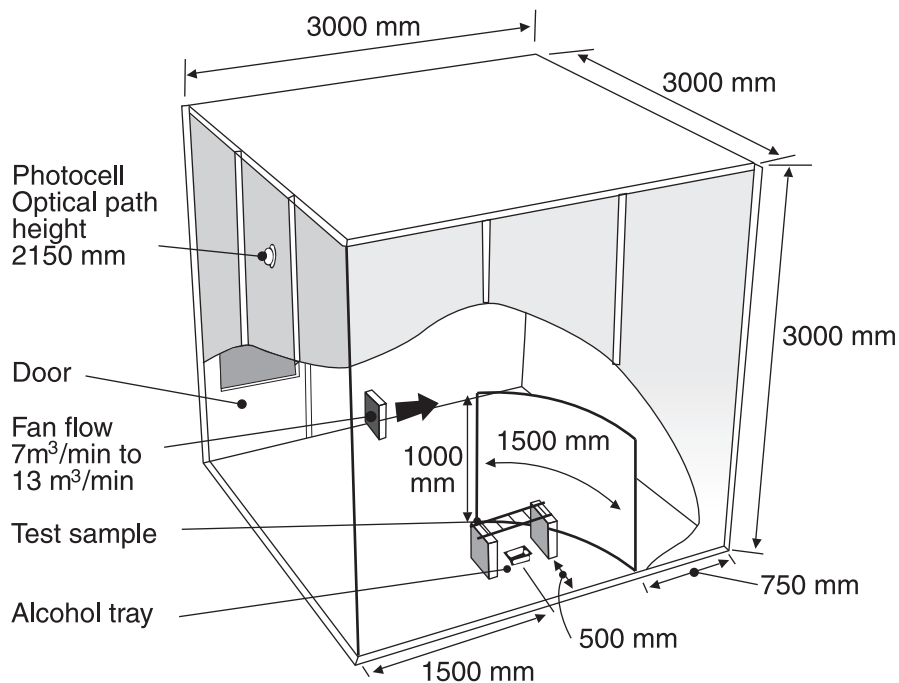

TEST ON GASES EVOLVED DURING COMBUSTION OF ELECTRIC CABLES

PURPOSE

The purpose of this test is to determine the pH and conductivity of gases evolved during the combustion of materials taken from electric cables as a function of temperature.

PRINCIPLE OF OPERATION

A predetermined quantity of the test material is burned in a tube furnace. The evolved gases are trapped by bubbling through bottles filled with distilled or demineralized water. The acidity is measured by determination of pH value. The conductivity of the solution is also measured.

EQUIPMENT

1. Test apparatus
2. pH meter
3. Conductivity meter
4. Analytical balance
5. Computer containing a measuring program
5. Deionized water

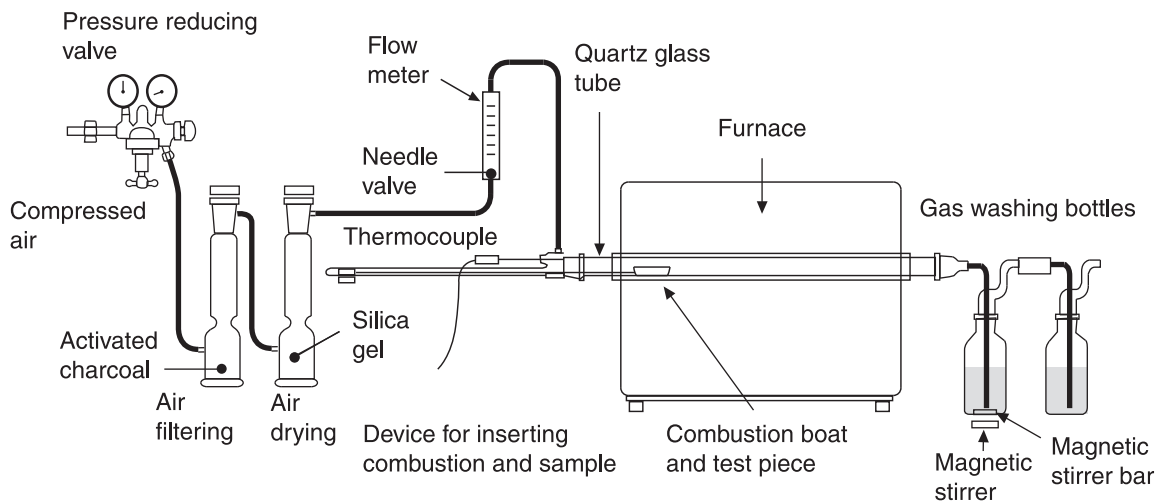



Cable mounted for fire test



Fire test in progress



Completion of fire test (The charred portion is less than the specified requirement)

PVC INSULATED, PVC SHEATHED CABLES

COPPER CONDUCTORS

STANDARD : IEC 60502-1

600/1000 VOLTS

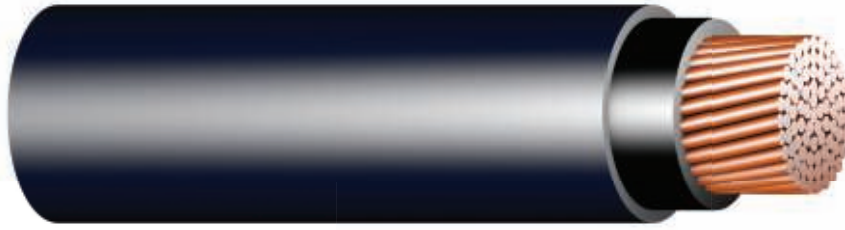

CABLE CORE(S)

Nominal Area	No. of wires	Approx. Conductor diameter	Nominal Insulation thickness
mm ²	No.	mm	mm
1x1.5 re	1	1.38	0.8
1x1.5 rm	7	1.56	0.8
1x2.5 re	1	1.78	0.8
1x2.5 rm	7	2.01	0.8
1x4 re	1	2.25	1.0
1x4 rm	7	2.55	1.0
1x6 re	1	2.76	1.0
1x6 rm	7	3.12	1.0
1x10 re	1	3.57	1.0
1x10 rm	7	4.01	1.0
1x16 rm	7	5.03	1.0
1x25 rm	7	6.3	1.2
1x35 rm	7	7.44	1.2
1x50 rm	19	8.8	1.4
1x70 rm	19	10.6	1.4
1x95 rm	19	12.4	1.6
1x120 rm	37	14	1.6
1x150 rm	37	15.5	1.8
1x185 rm	37	17.4	2.0
1x240 rm	61	20	2.2
1x300 rm	61	22.5	2.4
1x400 rm	61	25.4	2.6
1x500 rm	61	28.5	2.8
1x630 rm	91	32.8	2.8

CABLE CORE(S)

2x1.5 re	1	1.38	0.8
2x1.5 rm	7	1.56	0.8
2x2.5 re	1	1.78	0.8
2x2.5 rm	7	2.01	0.8
2x4 re	1	2.25	1.0
2x4 rm	7	2.55	1.0
2x6 re	1	2.76	1.0
2x6 rm	7	3.12	1.0
2x10 re	1	3.57	1.0
2x10 rm	7	4.01	1.0
2x16 rm	7	5.03	1.0
2x25 rm	7	6.3	1.2
2x35 rm	7	7.44	1.2

UNARMoured

Nominal Sheath thickness	Approx. Overall diameter	Approx. Weight	Packing
mm	mm	Kg/Km	meters
1.4	6	55	1000
1.4	6	55	1000
1.4	7	65	1000
1.4	7	70	1000
1.4	7	90	1000
1.4	8	95	1000
1.4	8	110	1000
1.4	8	120	1000
1.4	9	155	1000
1.4	9	165	1000
1.4	10	230	1000
1.4	12	335	1000
1.4	13	440	1000
1.4	15	575	1000
1.4	17	785	1000
1.5	19	1075	1000
1.5	21	1325	1000
1.6	23	1600	1000
1.7	25	2000	1000
1.8	28	2600	1000
1.9	32	3250	500
2.0	35	4150	500
2.1	39	5250	500
2.2	43	6700	500

UNARMoured

1.8	12	200	1000
1.8	13	200	1000
1.8	13	225	1000
1.8	14	275	1000
1.8	15	325	1000
1.8	16	350	1000
1.8	16	375	1000
1.8	17	400	1000
1.8	18	500	1000
1.8	19	550	1000
1.8	21	725	1000
1.8	24	1025	1000
1.8	26	1300	1000

re : Round Solid
rm : Round Stranded

Colour code (1)
1 Core : Black (Red on request)
2 Core : Red, Black

Colour code (2)
1 Core : Brown or Blue
2 Core : Brown, Blue.

Single core cables are Aluminium Armoured as per IEC 60502-1 recommendation.

PVC INSULATED, PVC SHEATHED CABLES

COPPER CONDUCTORS

STANDARD : IEC 60502-1

600/1000 VOLTS

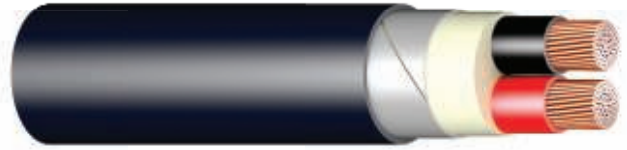
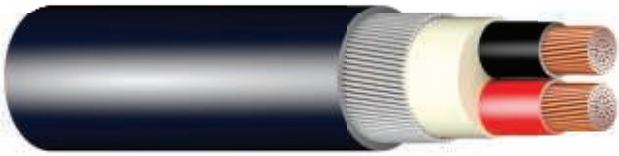

ALUMINIUM WIRE ARMoured

Nominal Alum/Steel Wire dia.	Nominal Sheath thickness	Approx. Overall diameter	Approx. Weight	Packing
mm	mm	mm	Kg/Km	meters
-	-	-	-	-
-	-	-	-	-
-	-	-	-	-
-	-	-	-	-
-	-	-	-	-
-	-	-	-	-
-	-	-	-	-
-	-	-	-	-
-	-	-	-	-
0.8	1.8	14	300	1000
0.8	1.8	15	375	1000
0.8	1.8	16	500	1000
0.8	1.8	18	625	1000
1.25	1.8	20	835	1000
1.25	1.8	22	1075	1000
1.25	1.8	24	1385	1000
1.6	1.8	26	1700	1000
1.6	1.8	28	2025	1000
1.6	1.8	31	2450	500
1.6	1.9	34	3100	500
2.0	2.0	38	3900	500
2.0	2.1	42	4875	500
2.0	2.2	45	6050	500
2.0	2.4	50	7625	500

ALUMINIUM TAPE ARMoured

Nominal Alum/Steel tape thickness	Nominal Sheath thickness	Approx. Overall diameter	Approx. Weight	Packing
mm	mm	mm	Kg/Km	meters
-	-	-	-	-
-	-	-	-	-
-	-	-	-	-
-	-	-	-	-
-	-	-	-	-
-	-	-	-	-
-	-	-	-	-
-	-	-	-	-
-	-	-	-	-
-	-	-	-	-
0.5	1.8	14	300	1000
0.5	1.8	15	375	1000
0.5	1.8	17	500	1000
0.5	1.8	18	625	1000
0.5	1.8	20	775	1000
0.5	1.8	21	1025	1000
0.5	1.8	24	1325	1000
0.5	1.8	25	1575	1000
0.5	1.8	27	1900	1000
0.5	1.8	29	2300	1000
0.5	1.9	33	2950	500
0.5	1.9	35	3600	500
0.5	2.1	40	4575	500
0.5	2.2	43	5725	500
0.5	2.3	48	7225	500

STEEL WIRE ARMoured

-	-	-	-	-
-	-	-	-	-
-	-	-	-	-
0.8	1.8	15	425	1000
0.8	1.8	17	500	1000
0.8	1.8	17	525	1000
1.25	1.8	19	700	1000
1.25	1.8	19	775	1000
1.25	1.8	20	825	1000
1.25	1.8	21	950	1000
1.25	1.8	23	1150	1000
1.6	1.8	27	1700	1000
1.6	1.8	29	2050	1000

DOUBLE STEEL TAPE ARMoured

-	-	-	-	-
-	-	-	-	-
-	-	-	-	-
0.2	1.8	15	325	1000
0.2	1.8	16	400	1000
0.2	1.8	16	425	1000
0.2	1.8	17	475	1000
0.2	1.8	18	500	1000
0.2	1.8	18	600	1000
0.2	1.8	19	650	1000
0.2	1.8	21	825	1000
0.2	1.8	25	1150	1000
0.2	1.8	27	1450	1000

Tolerance range :
 Overall diameter -2%, +8%
 Packing ± 5%

PVC INSULATED, PVC SHEATHED CABLES

COPPER CONDUCTORS

STANDARD : IEC 60502-1

600/1000 VOLTS

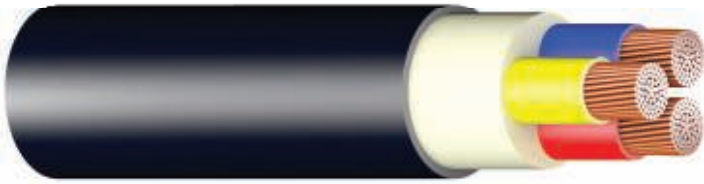

CABLE CORE(S)

Nominal Area	No. of wires	Approx. Conductor diameter	Nominal Insulation thickness
mm ²	No.	mm	mm
3x1.5 re	1	1.38	0.8
3x1.5 rm	7	1.56	0.8
3x2.5 re	1	1.78	0.8
3x2.5 rm	7	2.01	0.8
3x4 re	1	2.25	1.0
3x4 rm	7	2.55	1.0
3x6 re	1	2.76	1.0
3x6 rm	7	3.12	1.0
3x10 re	1	3.57	1.0
3x10 rm	7	4.01	1.0
3x16 rm	7	5.03	1.0
3x25 rm	7	6.3	1.2
3x35 rm	7	7.44	1.2
3x50 rm	19	8.8	1.4
3x70 rm	19	10.55	1.4
3x95 rm	19	12.4	1.6
3x120 rm	37	14.0	1.6
3x150 rm	37	15.47	1.8
3x185 rm	37	17.36	2.0
3x240 rm	61	20.25	2.2
3x300 rm	61	22.68	2.4
3x400 rm	61	25.38	2.6
3x500 rm	61	28.8	2.8

UNARMoured

Nominal Sheath thickness	Approx. Overall diameter	Approx. Weight	Packing
mm	mm	Kg/Km	meters
1.8	13	225	1000
1.8	13	225	1000
1.8	14	275	1000
1.8	14	285	1000
1.8	16	375	1000
1.8	16	400	1000
1.8	17	450	1000
1.8	18	475	1000
1.8	19	600	1000
1.8	19	650	1000
1.8	22	875	1000
1.8	25	1275	1000
1.8	28	1500	1000
1.8	32	1950	500
2.0	36	2700	500
2.1	41	3625	500
2.2	45	4425	500
2.3	49	5425	500
2.5	55	6750	250
2.7	63	8800	250
2.9	69	10925	250
3.1	77	13850	250
3.4	86	17500	250

CABLE CORE(S)

	Ph	Ne	Ph	Ne	Ph	Ne
3x10 rm+6	7	7	4.01	3.12	1.0	1.0
3x16 rm+10	7	7	5.03	4.01	1.0	1.0
3x25 rm+16	7	7	6.3	5.03	1.2	1.0
3x35 sm+16	6	7	-	5.03	1.2	1.0
3x50 sm+25	6	7	-	6.30	1.4	1.2
3x70 sm+35	12	7	-	7.44	1.4	1.2
3x95 sm+50	15	19	-	8.80	1.6	1.4
3x120 sm+70	18	19	-	10.60	1.6	1.4
3x150 sm+70	18	19	-	10.60	1.8	1.4
3x185 sm+95	30	19	-	12.40	2.0	1.6
3x240 sm+120	34	37	-	14.00	2.2	1.6
3x300 sm+150	34	37	-	15.50	2.4	1.8
3x400 sm+185	53	37	-	17.40	2.6	2.0
3x500 sm+240	53	61	-	20.00	2.8	2.2

UNARMoured

1.8	21	730	1000
1.8	23	1000	1000
1.8	27	1450	1000
1.8	27	1600	1000
1.9	31	2150	500
2.0	35	2950	500
2.2	39	3975	500
2.3	43	4975	500
2.4	47	5925	500
2.6	52	7425	250
2.8	58	9575	250
3.0	64	11850	250
3.2	72	15025	250
3.5	79	19025	250

re : Round Solid
 rm : Round Stranded
 sm : Sectoral Stranded
 Ph : Phase
 Ne : Neutral

Colour code (1)

3 Cores : Red, Yellow, Blue
 3 1/2 Cores : Red, Yellow, Blue, Black

Colour code (2)

3 Cores : Brown, Black, Grey
 3 1/2 Cores : Blue, Brown, Black, Grey

For 3 1/2 core, neutral conductors are round stranded.

For sectoral conductors, number of wires mentioned is minimum number of wires in accordance with IEC 60228.

PVC INSULATED, PVC SHEATHED CABLES

COPPER CONDUCTORS

STANDARD : IEC 60502-1

600/1000 VOLTS

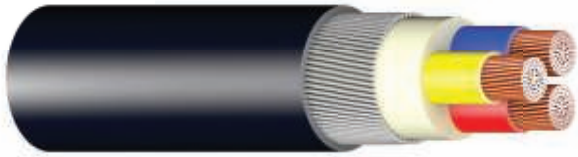

STEEL WIRE ARMoured

Steel Wire dia.	Nominal Sheath thickness	Approx. Overall diameter	Approx. Weight	Packing
mm	mm	mm	Kg/Km	meters
-	-	-	-	-
-	-	-	-	-
-	-	-	-	-
0.8	1.8	16	465	1000
1.25	1.8	18	685	1000
1.25	1.8	19	725	1000
1.25	1.8	19	800	1000
1.25	1.8	20	850	1000
1.25	1.8	21	1000	1000
1.25	1.8	22	1050	1000
1.25	1.8	24	1350	1000
1.6	1.8	29	1975	1000
1.6	1.8	31	2300	500
1.6	2.0	35	2900	500
2.0	2.1	40	4025	500
2.0	2.2	45	5150	500
2.0	2.3	49	6050	500
2.5	2.5	55	7725	250
2.5	2.7	60	9300	250
2.5	2.9	68	11700	250
2.5	3.1	75	14125	250
3.15	3.4	84	18400	250
3.15	3.6	92	22500	250

DOUBLE STEEL TAPE ARMoured

St. Tape Thickness	Nominal Sheath thickness	Approx. Overall diameter	Approx. Weight	Packing
mm	mm	mm	Kg/Km	meters
-	-	-	-	-
-	-	-	-	-
-	-	-	-	-
0.2	1.8	15	360	1000
0.2	1.8	17	450	1000
0.2	1.8	17	480	1000
0.2	1.8	18	540	1000
0.2	1.8	18	575	1000
0.2	1.8	19	700	1000
0.2	1.8	20	750	1000
0.2	1.8	23	1000	1000
0.2	1.8	26	1425	1000
0.2	1.8	29	1650	1000
0.2	1.9	33	2150	500
0.2	2.0	37	2900	500
0.5	2.2	43	4275	500
0.5	2.3	47	5150	500
0.5	2.5	52	6250	250
0.5	2.6	57	7625	250
0.5	2.8	65	9800	250
0.5	3.0	71	12050	250
0.5	3.3	79	15125	250
0.5	3.5	88	18900	250

STEEL WIRE ARMoured

1.25	1.8	23	1175	1000
1.6	1.8	26	1650	1000
1.6	1.8	30	2200	1000
1.6	1.9	30	2375	1000
2.0	2.0	35	3275	500
2.0	2.1	39	4200	500
2.0	2.3	44	5425	500
2.5	2.5	48	6950	500
2.5	2.6	52	8100	250
2.5	2.7	57	9775	250
2.5	2.9	63	12250	250
2.5	3.1	70	14775	250
0.3	3.5	79	19250	250
3.15	3.7	85	23625	250

DOUBLE STEEL TAPE ARMoured

0.2	1.8	21	850	1000
0.2	1.8	24	1150	1000
0.2	1.8	27	1600	1000
0.2	1.8	28	1750	1000
0.2	1.9	32	2350	500
0.2	2.1	36	3175	500
0.5	2.3	42	4600	500
0.5	2.4	45	5650	500
0.5	2.5	49	6675	500
0.5	2.7	54	8250	250
0.5	2.9	60	10500	250
0.5	3.1	66	12875	250
0.5	3.3	74	16175	250
0.8	3.6	83	21050	250

Tolerance range :
Overall diameter -2%, +8%
Packing ± 5%

PVC INSULATED, PVC SHEATHED CABLES

COPPER CONDUCTORS

STANDARD : IEC 60502-1

600/1000 VOLTS

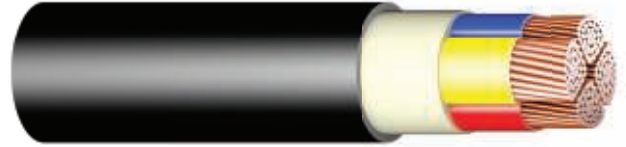
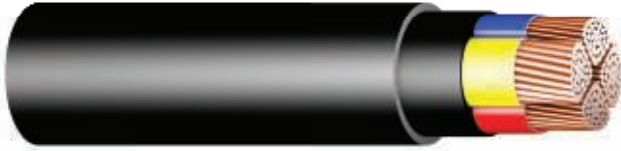

CABLE CORE(S)

Nominal Area	No. of wires	Approx. Conductor diameter	Nominal Insulation thickness
mm ²	No.	mm	mm
4x1.5 re	1	1.38	0.8
4x1.5 rm	7	1.56	0.8
4x2.5 re	1	1.78	0.8
4x2.5 rm	7	2.01	0.8
4x4 re	1	2.25	1.0
4x4 rm	7	2.55	1.0
4x6 re	1	2.76	1.0
4x6 rm	7	3.12	1.0
4x10 re	1	3.57	1.0
4x10 rm	7	4.01	1.0
4x16 rm	7	5.03	1.0
4x25 rm	7	6.3	1.2
4x35 sm	6	-	1.2
4x50 sm	6	-	1.4
4x70 sm	12	-	1.4
4x95 sm	15	-	1.6
4x120 sm	18	-	1.6
4x150 sm	18	-	1.8
4x185 sm	30	-	2.0
4x240 sm	34	-	2.2
4x300 sm	34	-	2.4
4x400 sm	53	-	2.6
4x500 sm	53	-	2.8

UNARMoured

Nominal Sheath thickness	Approx. Overall diameter	Approx. Weight	Packing
mm	mm	Kg/Km	meters
1.8	14	250	1000
1.8	14	275	1000
1.8	15	325	1000
1.8	15	325	1000
1.8	17	450	1000
1.8	18	475	1000
1.8	18	550	1000
1.8	19	575	1000
1.8	20	750	1000
1.8	21	800	1000
1.8	24	1100	1000
1.8	28	1600	1000
1.8	28	1800	1000
1.9	32	2400	500
2.1	36	3275	500
2.2	41	4425	500
2.4	45	5475	500
2.5	49	6700	500
2.7	55	8350	250
2.9	61	10765	250
3.1	67	13350	250
3.4	76	17000	250
3.6	83	21425	250

re : Round Solid
 rm : Round Stranded
 sm : Sectoral Stranded

Colour code (1)
 4 cores : Red, Yellow, Blue, Black

Colour code (2)
 4 cores : Blue, Brown, Black, Grey

For sectoral conductors, number of wires mentioned is minimum number of wires in accordance with IEC 60228.

PVC INSULATED, PVC SHEATHED CABLES

COPPER CONDUCTORS

STANDARD : IEC 60502-1

600/1000 VOLTS

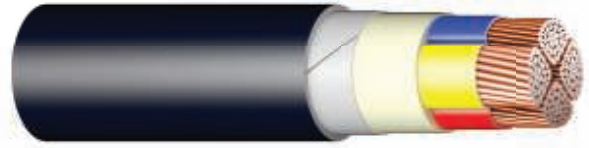
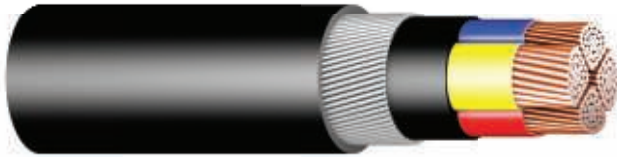

STEEL WIRE ARMoured

Steel Wire dia.	Nominal Sheath thickness	Approx. Overall diameter	Approx. Weight	Packing
mm	mm	mm	Kg/Km	meters
-	-	-	-	-
-	-	-	-	-
-	-	-	-	-
-	-	-	-	-
1.25	1.8	19	790	1000
1.25	1.8	20	825	1000
1.25	1.8	21	925	1000
1.25	1.8	21	975	1000
1.25	1.8	23	1175	1000
1.25	1.8	24	1250	1000
1.6	1.8	27	1750	1000
1.6	1.8	31	2375	500
1.6	1.9	31	2600	500
2.0	2.1	37	3625	500
2.0	2.2	40	4575	500
2.5	2.4	46	6350	500
2.5	2.5	50	7525	500
2.5	2.7	55	8950	250
2.5	2.9	60	10650	250
2.5	3.1	66	13575	250
2.5	3.3	73	16425	250
3.15	3.6	83	21500	250
3.15	3.9	91	26500	250

DOUBLE STEEL TAPE ARMoured

St. Tape Thickness	Nominal Sheath thickness	Approx. Overall diameter	Approx. Weight	Packing
mm	mm	mm	Kg/Km	meters
-	-	-	-	-
-	-	-	-	-
-	-	-	-	-
-	-	-	-	-
0.2	1.8	18	525	1000
0.2	1.8	18	575	1000
0.2	1.8	19	650	1000
0.2	1.8	20	675	1000
0.2	1.8	21	850	1000
0.2	1.8	22	900	1000
0.2	1.8	24	1225	1000
0.2	1.8	28	1750	1000
0.2	1.9	29	1975	1000
0.2	2.0	33	2625	500
0.5	2.2	38	3850	500
0.5	2.4	43	5100	500
0.5	2.5	47	6175	500
0.5	2.6	52	7475	250
0.5	2.8	57	9200	250
0.5	3.0	63	11725	250
0.5	3.2	69	14425	250
0.5	3.5	78	18200	250
0.8	3.8	87	23600	250

Tolerance range :

Overall diameter -2%, +8%

Packing ± 5%

PVC INSULATED, PVC SHEATHED CABLES

ALUMINIUM CONDUCTORS

STANDARD : IEC 60502-1

600/1000 VOLTS

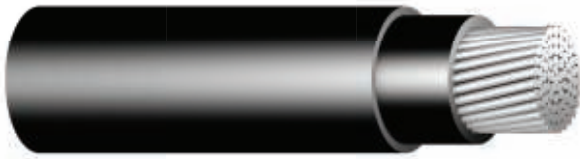

CABLE CORE(S)

Nominal Area	No. of wires	Approx. Conductor diameter	Nominal Insulation thickness
mm ²	No.	mm	mm
1x16 rm	7	4.98	1.0
1x25 rm	7	6.30	1.2
1x35 rm	7	7.41	1.2
1x50 rm	19	8.75	1.4
1x70 rm	19	10.55	1.4
1x95 rm	19	12.40	1.6
1x120 rm	37	14.00	1.6
1x150 rm	37	15.47	1.8
1x185 rm	37	17.36	2.0
1x240 rm	61	19.89	2.2
1x300 rm	61	22.23	2.4
1x400 rm	61	25.20	2.6
1x500 rm	61	28.62	2.8
1x630 rm	91	32.56	2.8

CABLE CORE(S)

2x16 rm	7	4.98	1.0
2x25 rm	7	6.30	1.2
2x35 rm	7	7.41	1.2

CABLE CORE(S)

3x16 rm	7	4.98	1.0
3x25 rm	7	6.30	1.2
3x35 rm	7	7.41	1.2
3x50 rm	19	8.75	1.4
3x70 rm	19	10.55	1.4
3x95 rm	19	12.4	1.6
3x120 rm	37	14.0	1.6
3x150 rm	37	15.47	1.8
3x185 rm	37	17.36	2.0
3x240 rrm	61	19.89	2.2
3x300 rm	61	22.23	2.4
3x400 rm	61	25.2	2.6
3x500 rm	61	28.62	2.8

UNARMoured

Nominal Sheath thickness	Approx. Overall diameter	Approx. Weight	Packing
mm	mm	Kg/Km	meters
1.4	10	135	1000
1.4	12	185	1000
1.4	13	225	1000
1.4	15	300	1000
1.4	17	375	1000
1.5	19	500	1000
1.5	21	600	1000
1.6	23	725	1000
1.7	25	900	1000
1.8	28	1150	1000
1.9	31	1400	500
2.0	35	1750	500
2.1	39	2200	500
2.2	43	2725	500

UNARMoured

1.8	20	525	1000
1.8	24	725	1000
1.8	26	875	1000

UNARMoured

1.8	22	600	1000
1.8	25	825	1000
1.8	28	875	1000
1.8	31	1100	500
2.0	36	1475	500
2.1	41	1925	500
2.2	45	2275	500
2.3	49	2775	500
2.5	55	3425	250
2.7	62	4375	250
2.9	68	5325	250
3.1	76	6675	250
3.4	85	8350	250

rm : Round Stranded
sm : Sectoral Stranded

Colour code (1)

1 Cores : Black (Red on request)
2 Cores : Red, Black
3 Cores : Red, Yellow, Blue

Colour code (2)

1 Cores : Brown or Blue
2 Cores : Brown, Blue
3 Cores : Brown, Black, Gray

Single core cables are Aluminium Armoured as per IEC 60502-1 recommendation.

For sectoral conductors, number of wires mentioned is minimum number of wires in accordance with IEC 60228

PVC INSULATED, PVC SHEATHED CABLES

ALUMINIUM CONDUCTORS

STANDARD : IEC 60502-1

600/1000 VOLTS

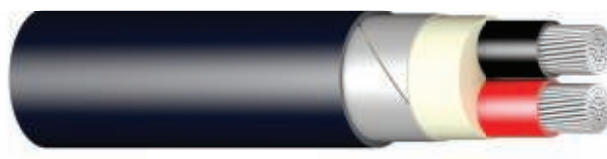
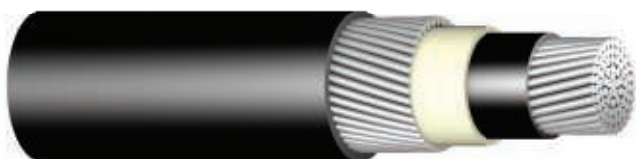

ALUMINIUM WIRE ARMoured

Nominal Alum/Steel Wire dia.	Nominal Sheath thickness	Approx. Overall diameter	Approx. Weight	Packing
mm	mm	mm	Kg/Km	meters
0.8	1.8	15	275	1000
0.8	1.8	16	350	1000
0.8	1.8	17	400	1000
1.25	1.8	20	550	1000
1.25	1.8	22	675	1000
1.25	1.8	24	825	1000
1.6	1.8	26	1000	1000
1.6	1.8	28	1150	1000
1.6	1.8	31	1350	500
1.6	1.9	34	1625	500
2.0	2.0	37	2050	500
2.0	2.1	41	2500	500
2.0	2.2	45	3050	500
2.0	2.4	50	3650	500

STEEL WIRE ARMoured

1.25	1.8	23	950	1000
1.6	1.8	27	1400	1000
1.6	1.8	29	1600	1000

STEEL WIRE ARMoured

1.25	1.8	24	1050	1000
1.6	1.8	28	1525	1000
1.6	1.8	31	1650	1000
1.6	2.0	35	2025	500
2.0	2.1	40	2800	500
2.0	2.2	45	3450	500
2.0	2.3	49	3900	500
2.5	2.5	55	5075	250
2.5	2.7	60	5975	250
2.5	2.9	67	7225	250
2.5	3.1	74	8475	250
3.15	3.4	83	11150	250
3.15	3.6	92	13325	250

ALUMINIUM TAPE ARMoured

Nominal Alum/Steel tape thickness	Nominal Sheath thickness	Approx. Overall diameter	Approx. Weight	Packing
mm	mm	mm	Kg/Km	meters
0.5	1.8	15	285	1000
0.5	1.8	17	375	1000
0.5	1.8	18	425	1000
0.5	1.8	20	500	1000
0.5	1.8	21	600	1000
0.5	1.8	24	750	1000
0.5	1.8	25	875	1000
0.5	1.8	27	1000	1000
0.5	1.8	29	1200	1000
0.5	1.9	32	1475	500
0.5	1.9	35	1750	500
0.5	2.1	39	2200	500
0.5	2.2	43	2700	500
0.5	2.3	48	3275	500

DOUBLE STEEL TAPE ARMoured

0.2	1.8	21	650	1000
0.2	1.8	25	850	1000
0.2	1.8	27	1025	1000

DOUBLE STEEL TAPE ARMoured

0.2	1.8	22	700	1000
0.2	1.8	26	975	1000
0.2	1.8	28	1025	1000
0.2	1.9	32	1300	500
0.2	2.0	37	1700	500
0.5	2.2	43	2575	500
0.5	2.3	47	3000	500
0.5	2.5	52	3600	250
0.5	2.6	57	4300	250
0.5	2.8	64	5350	250
0.5	3.0	70	6400	250
0.5	3.3	79	7950	250
0.5	3.5	87	9725	250

Tolerance range :
 Overall diameter -2%, +8%
 Packing ± 5%

PVC INSULATED, PVC SHEATHED CABLES

ALUMINIUM CONDUCTORS

STANDARD : IEC 60502-1

600/1000 VOLTS

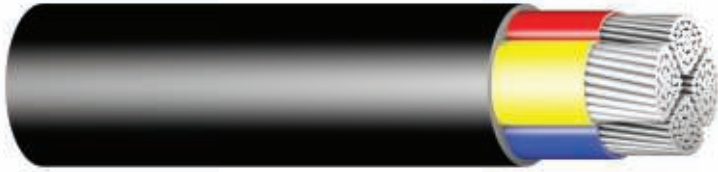

CABLE CORE(S)

Nominal Area	No. of wires		Approx. Conductor diameter		Nominal Insulation thickness	
	mm ²		mm		mm	
	Ph	Ne	Ph	Ne	Ph	Ne
3x25 rm+16	7	7	6.3	4.98	1.2	1.0
3x35 sm+16	6	7	-	4.98	1.2	1.0
3x50 sm+25	6	7	-	6.3	1.4	1.2
3x70 sm+35	12	7	-	7.41	1.4	1.2
3x95 sm+50	15	19	-	8.75	1.6	1.4
3x120 sm+70	15	19	-	10.55	1.6	1.4
3x150 sm+70	15	19	-	10.55	1.8	1.4
3x185 sm+95	30	19	-	12.4	2.0	1.6
3x240 sm+120	30	37	-	14.0	2.2	1.6
3x300 sm+150	30	37	-	15.47	2.4	1.8
3x400 sm+185	53	37	-	17.36	2.6	2.0
3x500 sm+240	53	61	-	19.89	2.8	2.2

CABLE CORE(S)

Nominal Area	No. of wires	Approx. Conductor diameter	Nominal Insulation thickness
4x16 rm	7	4.98	1.0
4x25 rm	7	6.30	1.2
4x35 sm	6	-	1.2
4x50 sm	6	-	1.4
4x70 sm	12	-	1.4
4x95 sm	15	-	1.6
4x120 sm	15	-	1.6
4x150 sm	15	-	1.8
4x185 sm	30	-	2.0
4x240 sm	30	-	2.2
4x300 sm	30	-	2.4
4x400 sm	53	-	2.6
4x500 sm	53	-	2.8

UNARMoured

Nominal Sheath thickness	Approx. Overall diameter	Approx. Weight	Packing
mm	mm	Kg/Km	meters
1.8	27	900	1000
1.8	27	875	1000
1.9	31	1150	500
2.0	34	1475	500
2.2	39	1950	500
2.3	43	2375	500
2.4	47	2800	500
2.6	52	3450	250
2.8	58	4400	250
3.0	64	5375	250
3.2	72	6775	250
3.5	79	8400	250

UNARMoured

Nominal Sheath thickness	Approx. Overall diameter	Approx. Weight	Packing
1.8	23	700	1000
1.8	28	1000	1000
1.8	28	925	1000
1.9	32	1250	500
2.1	36	1600	500
2.2	41	2100	500
2.4	45	2550	500
2.5	49	3075	500
2.7	55	3800	250
2.9	61	4825	250
3.1	67	5875	250
3.4	76	7475	250
3.6	83	9225	250

re : Round Solid
 rm : Round Stranded
 sm : Sectoral Stranded
 Ph : Phase Conductor
 Ne : Neutral Conductor

Colour code (1)
 3¹/₂ Cores : Red, Yellow, Blue, Black
 4 Cores : Red, Yellow, Blue, Black

Colour code (2)
 3¹/₂ Cores : Blue, Brown, Black, Grey
 4 Cores : Blue, Brown, Black, Grey

For 3¹/₂ cores, neutral conductors are round stranded.
 For sectoral conductors, number of wires mentioned is minimum number of wires in accordance with IEC 60228.

PVC INSULATED, PVC SHEATHED CABLES

ALUMINIUM CONDUCTORS

STANDARD : IEC 60502-1

600/1000 VOLTS

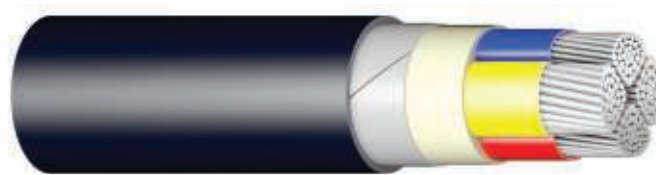
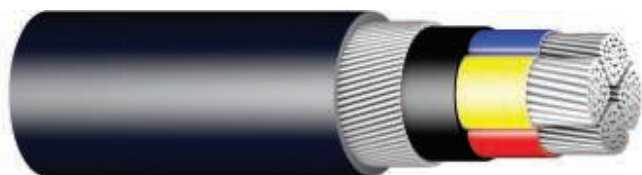

STEEL WIRE ARMoured

Steel Wire dia.	Nominal Sheath thickness	Approx. Overall diameter	Approx. Weight	Packing
mm	mm	mm	Kg/Km	meters
1.6	1.8	30	1675	1000
1.6	1.9	30	1650	1000
2.0	2.0	35	2250	500
2.0	2.1	39	2725	500
2.0	2.3	44	3400	500
2.5	2.5	48	4375	500
2.5	2.6	52	4975	250
2.5	2.7	57	5800	250
2.5	2.9	63	7075	250
2.5	3.1	70	8275	250
3.15	3.5	79	11000	250
3.15	3.7	87	13050	250

DOUBLE STEEL TAPE ARMoured

Steel Tape Thickness	Nominal Sheath thickness	Approx. Overall diameter	Approx. Weight	Packing
mm	mm	mm	Kg/Km	meters
0.2	1.8	27	1075	1000
0.2	1.8	27	1025	1000
0.2	1.9	32	1325	500
0.2	2.1	35	1700	500
0.5	2.3	42	2575	500
0.5	2.4	45	3050	500
0.5	2.5	49	3550	500
0.5	2.7	54	4275	250
0.5	2.9	60	5325	250
0.5	3.1	66	6375	250
0.5	3.3	74	7900	250
0.8	3.6	83	10425	250

STEEL WIRE ARMoured

1.6	1.8	27	1350	1000
1.6	1.8	31	1775	500
1.6	1.9	31	1750	500
2.0	2.1	37	2450	500
2.0	2.2	40	2900	500
2.5	2.4	46	4025	500
2.5	2.5	50	4600	500
2.5	2.7	55	5325	250
2.5	2.9	60	6300	250
2.5	3.1	66	7650	250
2.5	3.3	73	9075	250
3.15	3.6	83	11850	250
3.15	3.9	91	14125	250

DOUBLE STEEL TAPE ARMoured

0.2	1.8	24	850	1000
0.2	1.8	28	1150	1000
0.2	1.9	29	1125	1000
0.2	2.0	33	1475	500
0.5	2.2	38	2175	500
0.5	2.4	43	2775	500
0.5	2.5	47	3250	500
0.5	2.6	51	3850	250
0.5	2.8	57	4675	250
0.5	3.0	63	5800	250
0.5	3.2	69	6950	250
0.5	3.5	78	8675	250
0.8	3.8	87	11400	250

Tolerance range :
 Overall diameter -2%, +8%
 Packing ± 5%

XLPE INSULATED, PVC or LSHF SHEATHED CABLES

COPPER CONDUCTORS

STANDARD : IEC 60502-1

600/1000 VOLTS



CABLE CORE(S)

Nominal Area	No. of wires	Approx. Conductor diameter	Nominal Insulation thickness
mm ²	No.	mm	mm
1x1.5 re	1	1.38	0.7
1x1.5 rm	7	1.56	0.7
1x2.5 re	1	1.78	0.7
1x2.5 rm	7	2.01	0.7
1x4 re	1	2.25	0.7
1x4 rm	7	2.55	0.7
1x6 re	1	2.76	0.7
1x6 rm	7	3.12	0.7
1x10 rm	7	4.01	0.7
1x16 rm	7	5.03	0.7
1x25 rm	7	6.3	0.9
1x35 rm	7	7.44	0.9
1x50 rm	19	8.8	1.0
1x70 rm	19	10.6	1.1
1x95 rm	19	12.4	1.1
1x120 rm	37	14.0	1.2
1x150 rm	37	15.5	1.4
1x185 rm	37	17.4	1.6
1x240 rm	61	20.0	1.7
1x300 rm	61	22.5	1.8
1x400 rm	61	25.4	2.0
1x500 rm	61	28.5	2.2
1x630 rm	91	32.8	2.4

CABLE CORE(S)

2x1.5 re	1	1.38	0.7
2x1.5 rm	7	1.56	0.7
2x2.5 re	1	1.78	0.7
2x2.5 rm	7	2.01	0.7
2x4 re	1	2.25	0.7
2x4 rm	7	2.55	0.7
2x6 re	1	2.76	0.7
2x6 rm	7	3.12	0.7
2x10 rm	7	4.01	0.7
2x16 rm	7	5.03	0.7
2x25 rm	7	6.3	0.9
2x35 rm	7	7.44	0.9

UNARMoured

Nominal Sheath thickness	Approx. Overall diameter	Approx. Weight	Packing
mm	mm	Kg/Km	meters
1.4	6	45	1000
1.4	6	50	1000
1.4	6	60	1000
1.4	7	60	1000
1.4	7	75	1000
1.4	7	80	1000
1.4	7	95	1000
1.4	8	100	1000
1.4	9	145	1000
1.4	10	200	1000
1.4	11	300	1000
1.4	13	400	1000
1.4	14	525	1000
1.4	16	725	1000
1.5	18	1000	1000
1.5	20	1225	1000
1.6	22	1500	1000
1.6	24	1875	1000
1.7	27	2450	1000
1.8	30	3050	1000
1.9	34	3900	500
2.0	37	4975	500
2.2	42	6425	500

UNARMoured

1.8	12	175	1000
1.8	13	200	1000
1.8	13	225	1000
1.8	13	225	1000
1.8	14	275	1000
1.8	14	275	1000
1.8	15	325	1000
1.8	16	350	1000
1.8	17	475	1000
1.8	19	650	1000
1.8	23	925	1000
1.8	25	1200	1000

re : Round Solid
rm : Round Stranded

Colour code (1)

1 Cores : Black (Red on request)
2 Cores : Red, Black

Colour code (2)

1 Cores : Brown or Blue
4 Cores : Brown, Blue

Single core cables are Aluminium Armoured as per IEC 60502-1 recommendation.

XLPE INSULATED, PVC or LSHF SHEATHED CABLES

COPPER CONDUCTORS

STANDARD : IEC 60502-1

600/1000 VOLTS

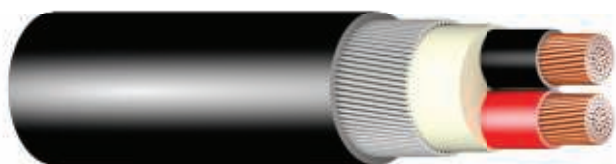

ALUMINIUM WIRE ARMoured

Nominal Alum/Steel Wire dia.	Nominal Sheath thickness	Approx. Overall diameter	Approx. Weight	Packing
mm	mm	mm	Kg/Km	meters
-	-	-	-	-
-	-	-	-	-
-	-	-	-	-
-	-	-	-	-
-	-	-	-	-
-	-	-	-	-
-	-	-	-	-
-	-	-	-	-
-	-	-	-	-
-	-	-	-	-
0.8	1.8	16	475	1000
0.8	1.8	17	575	1000
1.25	1.8	19	775	1000
1.25	1.8	21	1000	1000
1.25	1.8	23	1300	1000
1.6	1.8	26	1600	1000
1.6	1.8	28	1925	1000
1.6	1.8	30	2325	1000
1.6	1.9	33	2950	500
1.6	1.9	36	3575	500
2.0	2.1	40	4650	500
2.0	2.2	44	5775	500
2.0	2.3	49	7325	500

ALUMINIUM TAPE ARMoured

Nominal Alum/Steel tape thickness	Nominal Sheath thickness	Approx. Overall diameter	Approx. Weight	Packing
mm	mm	mm	Kg/Km	meters
-	-	-	-	-
-	-	-	-	-
-	-	-	-	-
-	-	-	-	-
-	-	-	-	-
-	-	-	-	-
-	-	-	-	-
-	-	-	-	-
-	-	-	-	-
-	-	-	-	-
-	-	-	-	-
0.5	1.8	16	475	1000
0.5	1.8	17	575	1000
0.5	1.8	19	725	1000
0.5	1.8	21	975	1000
0.5	1.8	23	1250	1000
0.5	1.8	24	1500	1000
0.5	1.8	26	1800	1000
0.5	1.8	29	2175	1000
0.5	1.8	31	2775	500
0.5	1.9	34	3400	500
0.5	2.0	38	4325	500
0.5	2.1	42	5450	500
0.5	2.3	47	6950	500

STEEL WIRE ARMoured

-	-	-	-	-
-	-	-	-	-
-	-	-	-	-
-	-	-	-	-
0.8	1.8	15	450	1000
0.8	1.8	16	475	1000
0.8	1.8	16	525	1000
0.8	1.8	17	550	1000
1.25	1.8	20	835	1000
1.25	1.8	22	1050	1000
1.6	1.8	26	1575	1000
1.6	1.8	28	1900	1000

DOUBLE STEEL TAPE ARMoured

-	-	-	-	-
-	-	-	-	-
-	-	-	-	-
-	-	-	-	-
0.2	1.8	15	350	1000
0.2	1.8	15	375	1000
0.2	1.8	16	400	1000
0.2	1.8	16	450	1000
0.2	1.8	18	575	1000
0.2	1.8	20	750	1000
0.2	1.8	24	1075	1000
0.2	1.8	26	1350	1000

Tolerance range :

Overall diameter -2%, +8%

Packing ± 5%

XLPE INSULATED, PVC or LSHF SHEATHED CABLES

COPPER CONDUCTORS

STANDARD : IEC 60502-1

600/1000 VOLTS



CABLE CORE(S)

Nominal Area	No. of wires	Approx. Conductor diameter	Nominal Insulation thickness
mm ²	No.	mm	mm
3x1.5 re	1	1.38	0.7
3x1.5 rm	7	1.56	0.7
3x2.5 re	1	1.78	0.7
3x2.5 rm	7	2.01	0.7
3x4 re	1	2.25	0.7
3x4 rm	7	2.55	0.7
3x6 re	1	2.76	0.7
3x6 rm	7	3.12	0.7
3x10 rm	7	4.01	0.7
3x16 rm	7	5.03	0.7
3x25 rm	7	6.3	0.9
3x35 rm	7	7.44	0.9
3x50 rm	19	8.8	1.0
3x70 rm	19	10.55	1.1
3x95 rm	19	12.4	1.1
3x120 rm	37	14.0	1.2
3x150 rm	37	15.47	1.4
3x185 rm	37	17.36	1.6
3x240 rm	61	20.25	1.7
3x300 rm	61	22.68	1.8
3x400 rm	61	25.38	2.0
3x500 rm	61	28.8	2.2

UNARMoured

Nominal Sheath thickness	Approx. Overall diameter	Approx. Weight	Packing
mm	mm	Kg/Km	meters
1.8	13	200	1000
1.8	13	210	1000
1.8	13	250	1000
1.8	14	275	1000
1.8	14	325	1000
1.8	15	325	1000
1.8	15	400	1000
1.8	16	400	1000
1.8	18	575	1000
1.8	20	800	1000
1.8	24	1150	1000
1.8	27	1375	1000
1.8	30	1800	1000
1.9	35	2500	500
2.0	39	3350	500
2.1	43	4150	500
2.3	48	5125	500
2.4	53	6375	250
2.6	60	8275	250
2.8	67	10275	250
3.1	74	13050	250
3.3	83	16625	250

CABLE CORE(S)

	Ph	Ne	Ph	Ne	Ph	Ne
3x10 rm+6	7	7	4.01	3.12	0.7	0.7
3x16 rm+10	7	7	5.03	4.01	0.7	0.7
3x25 rm+16	7	7	6.30	5.03	0.9	0.7
3x35 sm+16	6	7	-	5.03	0.9	0.7
3x50 sm+25	6	7	-	6.3	1.0	0.9
3x70 sm+35	12	7	-	7.44	1.1	0.9
3x95 sm+50	15	19	-	8.8	1.1	1.0
3x120 sm+70	18	19	-	10.6	1.2	1.1
3x150 sm+70	18	19	-	10.6	1.4	1.1
3x185 sm+95	30	19	-	12.4	1.6	1.1
3x240 sm+120	34	37	-	14.0	1.7	1.2
3x300 sm+150	34	37	-	15.5	1.8	1.4
3x400 sm+185	53	37	-	17.4	2.0	1.6
3x500 sm+240	53	61	-	20.0	2.2	1.7

UNARMoured

1.8	19	640	1000
1.8	22	900	1000
1.8	25	1325	1000
1.8	25	1475	1000
1.8	29	1950	1000
1.9	33	2750	500
2.1	37	3675	500
2.2	40	4600	500
2.3	45	5550	500
2.5	50	6975	500
2.7	55	9275	250
2.9	61	11150	250
3.1	68	14500	250
3.4	76	18050	250

re : Round Solid
 rm : Round Stranded
 sm : Sectoral Stranded
 Ph : Phase Conductor
 Ne : Neutral Conductor

Colour code (1)
 3 Core : Red, Yellow, Blue
 3 1/2 Core : Red, Yellow, Blue, Black

Colour code (2)
 3 Core : Brown, Black, Grey
 3 1/2 Core : Blue, Brown, Black, Grey

For 3 1/2 cores, neutral conductors are round stranded.
 For sectoral conductors, number of wires mentioned is minimum number of wires as per IEC 60228.

XLPE INSULATED, PVC or LSHF SHEATHED CABLES

COPPER CONDUCTORS

STANDARD : IEC 60502-1

600/1000 VOLTS

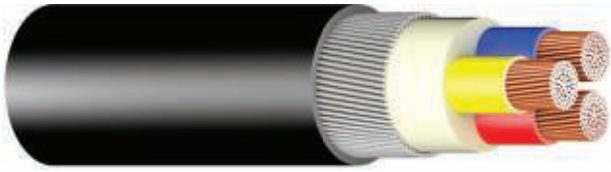

STEEL WIRE ARMoured

Steel Wire dia.	Nominal Sheath thickness	Approx. Overall diameter	Approx. Weight	Packing
mm	mm	mm	Kg/Km	meters
-	-	-	-	-
-	-	-	-	-
-	-	-	-	-
-	-	-	-	-
-	-	-	-	-
0.8	1.8	17	525	1000
0.8	1.8	17	575	1000
0.8	1.8	18	625	1000
1.25	1.8	21	950	1000
1.25	1.8	23	1225	1000
1.6	1.8	27	1825	1000
1.6	1.8	30	2125	1000
1.6	1.9	33	2650	500
2.0	2.0	39	3775	500
2.0	2.2	43	4800	500
2.0	2.3	47	5750	500
2.5	2.5	53	7325	250
2.5	2.6	58	8825	250
2.5	2.8	66	11100	250
2.5	3.0	72	13350	250
2.5	3.2	79	16425	250
3.15	3.5	90	21450	250

DOUBLE STEEL TAPE ARMoured

Steel Tape Thickness	Nominal Sheath thickness	Approx. Overall diameter	Approx. Weight	Packing
mm	mm	mm	Kg/Km	meters
-	-	-	-	-
-	-	-	-	-
-	-	-	-	-
-	-	-	-	-
-	-	-	-	-
0.2	1.8	16	410	1000
0.2	1.8	16	475	1000
0.2	1.8	17	500	1000
0.2	1.8	19	675	1000
0.2	1.8	21	900	1000
0.2	1.8	25	1300	1000
0.2	1.8	27	1525	1000
0.2	1.8	31	1975	500
0.2	2.0	36	2750	500
0.2	2.1	40	3600	500
0.5	2.3	45	4875	500
0.5	2.4	50	5900	500
0.5	2.6	55	7250	250
0.5	2.7	63	9250	250
0.5	2.9	69	11350	250
0.5	3.2	76	14225	250
0.5	3.4	85	17950	250

STEEL WIRE ARMoured

1.25	1.8	22	1050	1000
1.25	1.8	24	1350	1000
1.6	1.8	28	2000	1000
1.6	1.8	28	2175	1000
1.6	1.9	32	2775	500
2.0	2.1	37	3950	500
2.0	2.2	41	5000	500
2.0	2.4	45	6100	500
2.5	2.5	50	7650	500
2.5	2.7	55	9275	250
2.5	2.9	61	11575	250
2.5	3.0	66	13900	250
3.15	3.4	76	18250	250
3.15	3.6	83	22650	250

DOUBLE STEEL TAPE ARMoured

0.2	1.8	20	750	1000
0.2	1.8	22	1025	1000
0.2	1.8	26	1475	1000
0.2	1.8	26	1625	1000
0.2	1.9	30	2150	1000
0.2	2.0	34	2950	500
0.5	2.2	39	4250	500
0.5	2.3	43	5250	500
0.5	2.5	47	6275	500
0.5	2.6	52	7775	250
0.5	2.8	58	9900	250
0.5	3.0	63	12125	250
0.5	3.3	71	15250	250
0.5	3.5	78	19275	250

Tolerance range :
 Overall diameter -2%, +8%
 Packing ± 5%

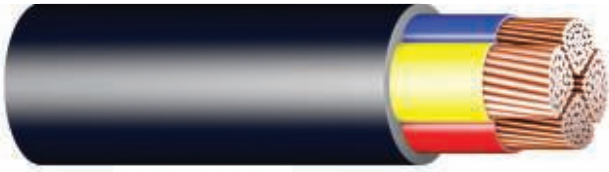

CABLE CORE(S)

Nominal Area	No. of wires	Approx. Conductor diameter	Nominal Insulation thickness
mm ²	No.	mm	mm
4x1.5 re	1	1.38	0.7
4x1.5 rm	7	1.56	0.7
4x2.5 re	1	1.78	0.7
4x2.5 rm	7	2.01	0.7
4x4 re	1	2.25	0.7
4x4 rm	7	2.55	0.7
4x6 re	1	2.76	0.7
4x6 rm	7	3.12	0.7
4x10 rm	7	4.01	0.7
4x16 rm	7	5.03	0.7
4x25 rm	7	6.3	0.9
4x35 sm	6	-	0.9
4x50 sm	6	-	1.0
4x70 sm	12	-	1.1
4x95 sm	15	-	1.1
4x120 sm	18	-	1.2
4x150 sm	18	-	1.4
4x185 sm	30	-	1.6
4x240 sm	34	-	1.7
4x300 sm	34	-	1.8
4x400 sm	53	-	2.0
4x500 sm	53	-	2.2

UNARMoured

Nominal Sheath thickness	Approx. Overall diameter	Approx. Weight	Packing
mm	mm	Kg/Km	meters
1.8	13	230	1000
1.8	14	250	1000
1.8	14	300	1000
1.8	15	300	1000
1.8	15	375	1000
1.8	16	400	1000
1.8	17	475	1000
1.8	17	500	1000
1.8	20	700	1000
1.8	22	975	1000
1.8	26	1450	1000
1.8	26	1650	1000
1.9	30	2175	1000
2.0	34	3050	500
2.1	38	4100	500
2.3	43	5125	500
2.4	47	6300	500
2.6	52	7825	250
2.8	58	10150	250
3.0	64	12575	250
3.3	73	16075	250
3.5	80	20375	250

re : Round Solid
 rm : Round Stranded
 sm : Sectoral Stranded

Colour code (1)
 4 Core : Red, Yellow, Blue, Black

Colour code (2)
 4 Cores : Blue, Brown, Black, Grey

For sectoral conductors, number of wires mentioned is minimum number of wires in accordance with IEC 60228.

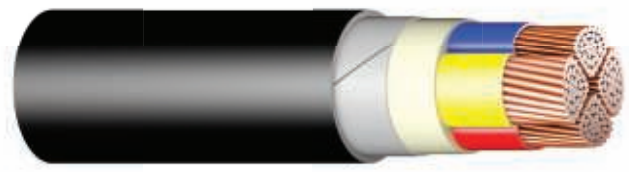
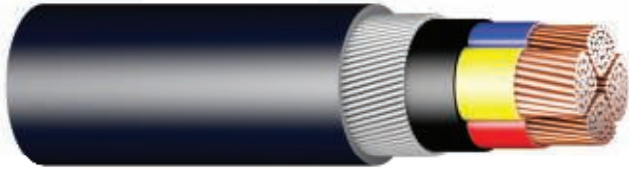

STEEL WIRE ARMoured

Steel Wire dia.	Nominal Sheath thickness	Approx. Overall diameter	Approx. Weight	Packing
mm	mm	mm	Kg/Km	meters
-	-	-	-	-
-	-	-	-	-
-	-	-	-	-
-	-	-	-	-
-	-	-	-	-
0.8	1.8	18	600	1000
1.25	1.8	19	800	1000
1.25	1.8	20	850	1000
1.25	1.8	22	1100	1000
1.6	1.8	25	1600	1000
1.6	1.8	29	2175	1000
1.6	1.9	30	2400	1000
1.6	2.0	33	3025	500
2.0	2.2	39	4325	500
2.0	2.3	43	5500	500
2.5	2.5	48	7075	500
2.5	2.6	52	8425	250
2.5	2.8	57	10200	250
2.5	3.0	64	12850	250
2.5	3.2	70	15550	250
3.15	3.5	80	20450	250
3.15	3.8	88	25225	250

DOUBLE STEEL TAPE ARMoured

St. Tape Thickness	Nominal Sheath thickness	Approx. Overall diameter	Approx. Weight	Packing
mm	mm	mm	Kg/Km	meters
-	-	-	-	-
-	-	-	-	-
-	-	-	-	-
-	-	-	-	-
-	-	-	-	-
0.2	1.8	17	475	1000
0.2	1.8	17	550	1000
0.2	1.8	18	600	1000
0.2	1.8	20	800	1000
0.2	1.8	23	1100	1000
0.2	1.8	27	1600	1000
0.2	1.8	27	1800	1000
0.2	1.9	31	2350	500
0.2	2.1	35	3275	500
0.5	2.3	41	4725	500
0.5	2.4	45	5800	500
0.5	2.6	49	7050	500
0.5	2.7	54	8650	250
0.5	2.9	60	11075	250
0.5	3.1	66	13600	250
0.5	3.4	75	17250	250
0.8	3.7	84	22475	250

Tolerance range :
 Overall diameter -2%, +8%
 Packing ± 5%

XLPE INSULATED, PVC or LSHF SHEATHED CABLES

ALUMINIUM CONDUCTORS

STANDARD : IEC 60502-1

600/1000 VOLTS

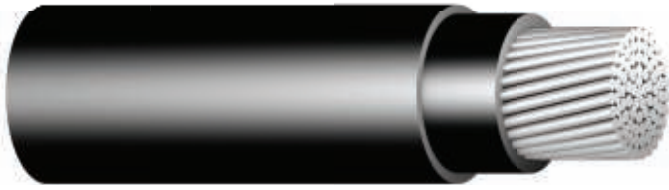

CABLE CORE(S)

Nominal Area	No. of wires	Approx. Conductor diameter	Nominal Insulation thickness
mm ²	No.	mm	mm
1x16 rm	7	5.0	0.7
1x25 rm	7	6.30	0.9
1x35 rm	7	7.41	0.9
1x50 rm	19	8.8	1.0
1x70 rm	19	10.55	1.1
1x95 rm	19	12.4	1.1
1x120 rm	37	14.0	1.2
1x150 rm	37	15.5	1.4
1x185 rm	37	17.4	1.6
1x240 rm	61	19.9	1.7
1x300 rm	61	22.2	1.8
1x400 rm	61	25.2	2.0
1x500 rm	61	28.6	2.2
1x630 rm	91	32.6	2.4

CABLE CORE(S)

2x16 rm	7	5.0	0.7
2x25 rm	7	6.30	0.9
2x35 rm	7	7.41	0.9

CABLE CORE(S)

3x16 rm	7	5.0	0.7
3x25 rm	7	6.30	0.9
3x35 rm	7	7.41	0.9
3x50 rm	19	8.8	1.0
3x70 rm	19	10.55	1.1
3x95 rm	19	12.4	1.1
3x120 rm	37	14.0	1.2
3x150 rm	37	15.5	1.4
3x185 rm	37	17.4	1.6
3x240 rm	61	19.9	1.7
3x300 rm	61	22.2	1.8
3x400 rm	61	25.2	2.0
3x500 rm	61	28.6	2.2

UNARMoured

Nominal Sheath thickness	Approx. Overall diameter	Approx. Weight	Packing
mm	mm	Kg/Km	meters
1.4	10	110	1000
1.4	11	150	1000
1.4	12	200	1000
1.4	14	250	1000
1.4	16	325	1000
1.5	18	425	1000
1.5	20	525	1000
1.6	22	650	1000
1.6	24	775	1000
1.7	27	1000	1000
1.8	30	1200	1000
1.9	33	1525	500
2.0	37	1925	500
2.2	42	2475	500

UNARMoured

1.8	19	450	1000
1.8	23	625	1000
1.8	25	775	1000

UNARMoured

1.8	20	500	1000
1.8	24	700	1000
1.8	26	750	1000
1.8	30	1785	500
1.9	35	2500	500
2.0	39	3340	500
2.1	43	4150	500
2.3	48	5120	500
2.4	53	6350	250
2.6	60	8280	250
2.8	66	10270	250
3.1	74	13040	250
3.3	83	16610	250

rm : Round Stranded
sm : Sectoral Stranded

Colour code (1)

1 Cores : Black (Red on Request)
2 Cores : Red, Black
3 Cores : Red, Yellow, Blue

Colour code (2)

1 Core : Brown or Blue
2 Cores : Brown, Blue
3 Cores : Brown, Black, Grey

Single core cables are Aluminium Armoured as per IEC 60502-1 recommendation.

For sectoral conductors, number of wires mentioned is minimum number of wires in accordance with IEC 60228

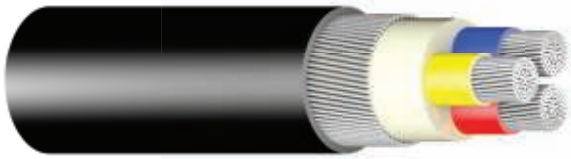

ALUMINIUM WIRE ARMoured

Nominal Alum/Steel Wire dia.	Nominal Sheath thickness	Approx. Overall diameter	Approx. Weight	Packing
mm	mm	mm	Kg/Km	meters
-	-	-	-	-
-	-	-	-	-
-	-	-	-	-
1.25	1.8	19	500	1000
1.25	1.8	21	600	1000
1.25	1.8	23	725	1000
1.6	1.8	26	900	1000
1.6	1.8	27	1025	1000
1.6	1.8	30	1225	1000
1.6	1.9	33	1475	500
1.6	1.9	35	1725	500
2.0	2.1	40	2275	500
2.0	2.2	44	2750	500
2.0	2.3	49	3350	500

ALUMINIUM TAPE ARMoured

Nominal Alum/Steel tape thickness	Nominal Sheath thickness	Approx. Overall diameter	Approx. Weight	Packing
mm	mm	mm	Kg/Km	meters
-	-	-	-	-
-	-	-	-	-
-	-	-	-	-
0.5	1.8	19	450	1000
0.5	1.8	21	550	1000
0.5	1.8	23	675	1000
0.5	1.8	24	775	1000
0.5	1.8	26	900	1000
0.5	1.8	29	1075	1000
0.5	1.8	31	1300	500
0.5	1.9	34	1550	500
0.5	2.0	38	1950	500
0.5	2.1	42	2400	500
0.5	2.3	47	3000	500

STEEL WIRE ARMoured

1.25	1.8	22	850	1000
1.6	1.8	26	1265	1000
1.6	1.8	28	1475	1000

DOUBLE STEEL TAPE ARMoured

0.2	1.8	20	550	1000
0.2	1.8	24	750	1000
0.2	1.8	26	925	1000

STEEL WIRE ARMoured

1.25	1.8	23	925	1000
1.6	1.8	27	1375	1000
1.6	1.8	30	1475	1000
1.6	1.9	33	2640	500
2.0	2.0	39	3770	500
2.0	2.2	43	4795	500
2.0	2.3	47	5740	500
2.5	2.5	53	7330	250
2.5	2.6	58	8820	250
2.5	2.8	66	11090	250
2.5	3.0	72	13340	250
2.5	3.2	79	16420	250
3.15	3.5	90	21450	250

DOUBLE STEEL TAPE ARMoured

0.2	1.8	21	625	1000
0.2	1.8	25	850	1000
0.2	1.8	27	900	1000
0.2	1.8	31	1960	500
0.2	2.0	36	2730	500
0.2	2.1	40	3600	500
0.5	2.3	45	4860	500
0.5	2.4	50	5890	500
0.5	2.6	55	7230	250
0.5	2.7	63	9250	250
0.5	2.9	69	11330	250
0.5	3.2	76	14230	250
0.5	3.4	85	17940	250

Tolerance range :
 Overall diameter -2%, +8%
 Packing ± 5%



CABLE CORE(S)

Nominal Area	No. of wires		Approx. Conductor diameter		Nominal Insulation thickness	
	No.		mm		mm	
	Ph	Ne	Ph	Ne	Ph	Ne
3x25 rm+16	7	7	6.3	4.98	0.9	0.7
3x35 sm+16	6	7	-	4.98	0.9	0.7
3x50 sm+25	6	7	-	6.3	1.0	0.9
3x70 sm+35	12	7	-	7.41	1.1	0.9
3x95 sm+50	15	19	-	8.75	1.1	1.0
3x120 sm+70	15	19	-	10.55	1.2	1.1
3x150 sm+70	15	19	-	10.55	1.4	1.1
3x185 sm+95	30	19	-	12.4	1.6	1.1
3x240 sm+120	30	37	-	14.0	1.7	1.2
3x300 sm+150	30	37	-	15.47	1.8	1.4
3x400 sm+185	53	37	-	17.36	2.0	1.6
3x500 sm+240	53	61	-	19.89	2.2	1.7

CABLE CORE(S)

Nominal Area	No. of wires	Approx. Conductor diameter	Nominal Insulation thickness
4x16 rm	7	4.98	0.7
4x25 rm	7	6.30	0.9
4x35 sm	6	-	0.9
4x50 sm	6	-	1.0
4x70 sm	12	-	1.1
4x95 sm	15	-	1.1
4x120 sm	15	-	1.2
4x150 sm	15	-	1.4
4x185 sm	30	-	1.6
4x240 sm	30	-	1.7
4x300 sm	30	-	1.8
4x400 sm	53	-	2.0
4x500 sm	53	-	2.2

UNARMoured

Nominal Sheath thickness	Approx. Overall diameter	Approx. Weight	Packing
mm	mm	Kg/Km	meters
1.8	25	775	1000
1.8	25	750	1000
1.8	29	950	1000
1.9	33	1275	500
2.1	37	1650	500
2.2	40	2000	500
2.3	45	2425	500
2.5	50	3000	500
2.7	55	3850	250
2.9	61	4650	250
3.1	68	5875	250
3.4	76	7425	250

UNARMoured

Nominal Sheath thickness	Approx. Overall diameter	Approx. Weight	Packing
1.8	22	600	1000
1.8	26	850	1000
1.8	26	800	1000
1.9	30	1025	1000
2.0	34	1375	500
2.1	38	1775	500
2.3	43	2200	500
2.4	47	2675	500
2.6	52	3275	250
2.8	58	4225	250
3.0	64	5100	250
3.3	73	6550	250
3.5	80	8175	250

re : Round Solid
 rm : Round Stranded
 sm : Sectoral Stranded
 Ph : Phase Conductor
 Ne : Neutral Conductor

Colour code (1)
 3 1/2 Cores : Red, Yellow, Blue, Black
 4 Cores : Red, Yellow, Blue, Black

Colour code (2)
 3 1/2 Cores : Blue, Brown, Black, Grey
 4 Cores : Blue, Brown, Black, Grey

For 3 1/2 cores, neutral conductors are round stranded.
 For sectoral conductors, number of wires mentioned is minimum number of wires in accordance with IEC 60228.

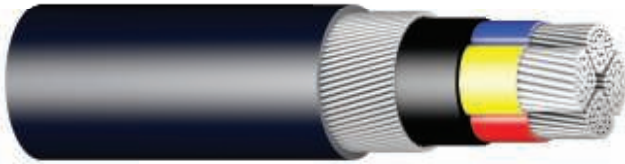

STEEL WIRE ARMoured

Steel Wire dia.	Nominal Sheath thickness	Approx. Overall diameter	Approx. Weight	Packing
mm	mm	mm	mm	mm
1.6	1.8	28	1475	1000
1.6	1.8	28	1450	1000
1.6	1.9	32	1775	500
2.0	2.1	37	2475	500
2.0	2.2	41	2975	500
2.0	2.4	45	3500	500
2.5	2.5	50	4510	500
2.5	2.7	55	5300	250
2.5	2.9	61	6400	250
2.5	3.0	66	7400	250
3.15	3.4	76	9875	250
3.15	3.6	83	11875	250

DOUBLE STEEL TAPE ARMoured

Steel Tape Thickness	Nominal Sheath thickness	Approx. Overall diameter	Approx. Weight	Packing
mm	mm	mm	Kg/Km	meters
0.2	1.8	26	925	1000
0.2	1.8	26	885	1000
0.2	1.9	30	1125	1000
0.2	2.0	34	1485	500
0.5	2.2	39	2225	500
0.5	2.3	43	2650	500
0.5	2.5	47	3175	500
0.5	2.6	52	3800	250
0.5	2.8	58	4725	250
0.5	3.0	63	5625	250
0.5	3.3	71	7000	250
0.5	3.5	78	8650	250

STEEL WIRE ARMoured

1.6	1.8	25	1200	1000
1.6	1.8	29	1575	1000
1.6	1.9	30	1550	1000
1.6	2.0	33	1875	500
2.0	2.2	39	2650	500
2.0	2.3	43	3175	500
2.5	2.5	48	4175	500
2.5	2.6	52	4850	250
2.5	2.8	57	5650	250
2.5	3.0	64	6900	250
2.5	3.2	70	8175	250
3.15	3.5	80	10950	250
3.15	3.8	88	13000	250

DOUBLE STEEL TAPE ARMoured

0.2	1.8	23	725	1000
0.2	1.8	27	1000	1000
0.2	1.8	27	950	1000
0.2	1.9	31	1200	500
0.2	2.1	35	1600	500
0.5	2.3	41	2400	500
0.5	2.4	45	2875	500
0.5	2.6	50	3450	500
0.5	2.7	54	4000	250
0.5	2.9	60	5150	250
0.5	3.1	66	6125	250
0.5	3.4	75	7700	250
0.8	3.7	84	10250	250

Tolerance range :
 Overall diameter -2%, +8%
 Packing ± 5%

Drum Handling Instructions

Cables and Conductors should be installed by trained personnel in accordance with good engineering practices, recognized codes of practice, statutory local requirements, IEE wiring regulations and where relevant, in accordance with any specific instructions issued by the company. Cables are often supplied in heavy cable reels and handling these reels can constitute a safety hazard. In particular, dangers may arise during the removal of steel binding straps and during the removal of retaining battens and timbers which may expose projecting nails.

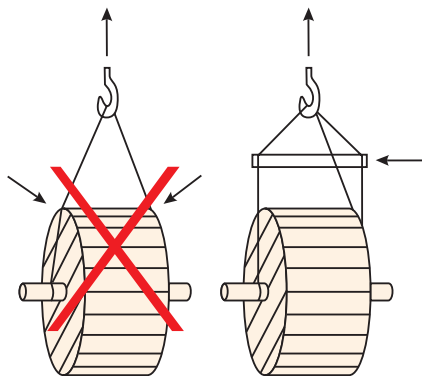

Lifting cable drums using crane.

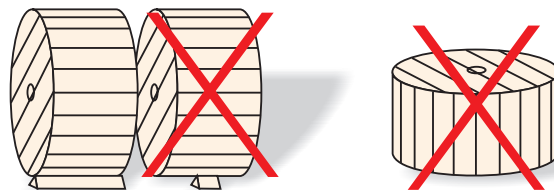

Do not lay drums flat on their sides, use proper stops to prevent drums rolling.

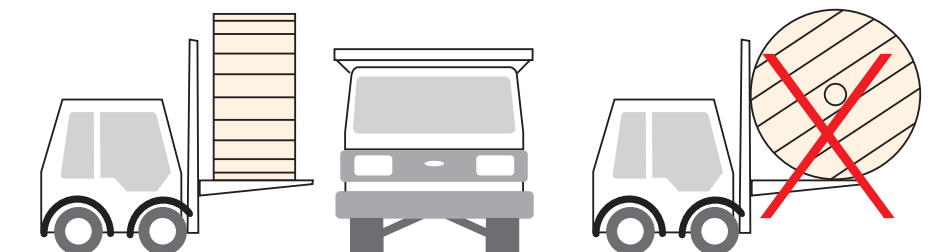

Lift drums on fork trucks correctly.

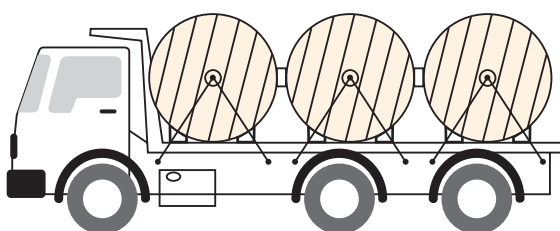

Secure drums adequately before transportation.

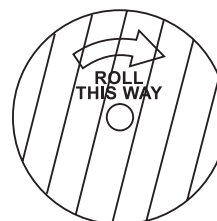

Roll in the direction shown by the arrow.

NOTICE

RCGC catalogues under circulation are still valid. Some International and National Standards mentioned in RCGC Catalogues might get Amended and Revised by respective organizations without prior notice. For Riyadh Cables Products, the latest amendments of applicable standards under circulation are applicable, except for the colour code. Colour code of cables manufactured by Riyadh Cables Group of Companies shall only be as listed below (Colour Code (1)):

1 Core: Red or Black

2 Core: Red, Black

3 Core: Red, Yellow, Blue

4 Core: Red, Yellow, Blue, Black

5 Core: Red, Yellow, Blue, Black, Green

More than five cores: Black cores with white printed numerals.

The above is because: SASO. All power utilities in the Kingdom of Saudi Arabia and GCC including Ministries, Oil industries specify the colour code as above and the same is mentioned in their specifications.

However, Colour code (2) can be provided if quantity is economically feasible

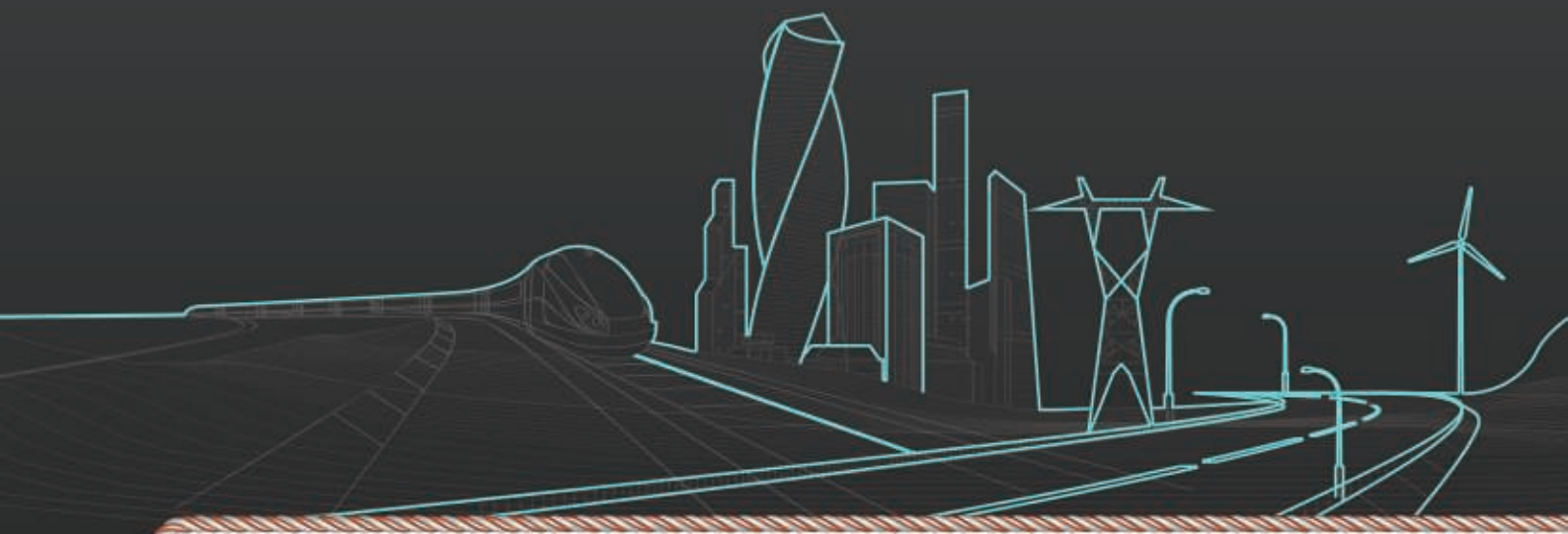

P.O. BOX 26862 RIYADH 11496 KSA TEL: +966 11 2651415 FAX: +966 11 2651423
E-mail:rcgc@riyadh-cables.com | www.riyadh-cables.com